

Article number: 20476716

Description: E+G Tommy screw with movable bar
DIN 6306M 16-90-E

Measures

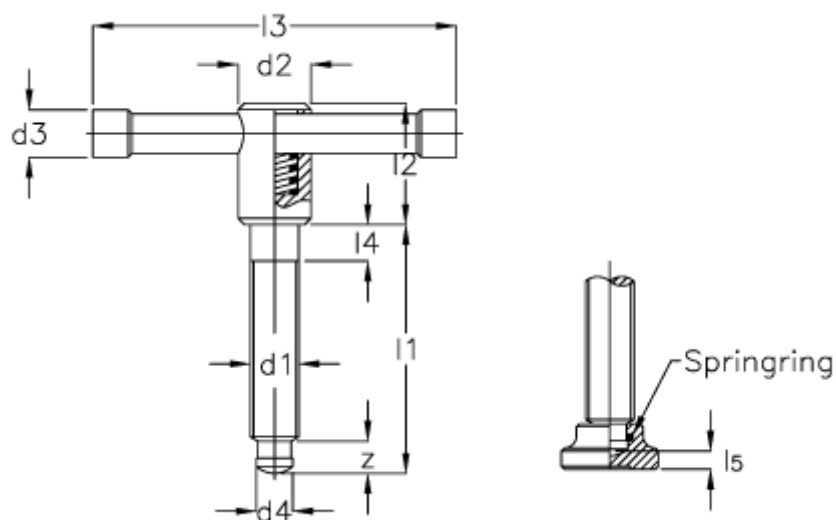

d1	= M 16	l5 = 5.3
d2	= 24	z = 10.6
d3	= 13	
d4	h11 = 12.0	
l1	= 90	
l2	= 40	
l3	= 120	
l4	= 10	